

ORDER INFORMATION:

A1253AWR-**-F1CB1-R
PART No. _____
No.OF CIRCUITS: _____
02~15
PLASTIC MATERIAL: _____ PAC

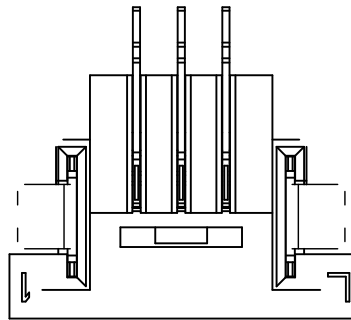
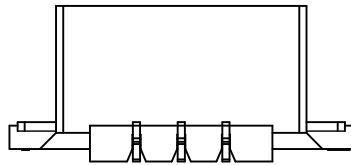
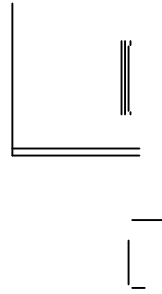
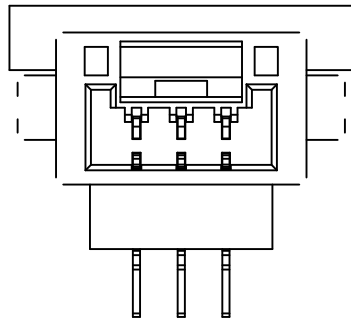

A

B

C

D

E

F

REV	ECN No.	DESCRIPTION	DESIGN	DATE
A	-	NEW RELEASE	吴丹平	2017.10.12

1

1

2

2

3

3

4

4

5

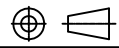
C					
B					
A	HOUSING	2~16 PCS	PA66	COLOR:WHITE	
ITEM	COMPONENT	Q'TY	MATERIAL	FINISH	
温州健坤接插				TITLE: A1253Y	
		USE:	PART NO.:		
		APPD:			
		CHKD:	DWG NO.:		
--	--	DR:	SCALE	SHEET	
	UNITS: mm				

A

B

C

D

E

F

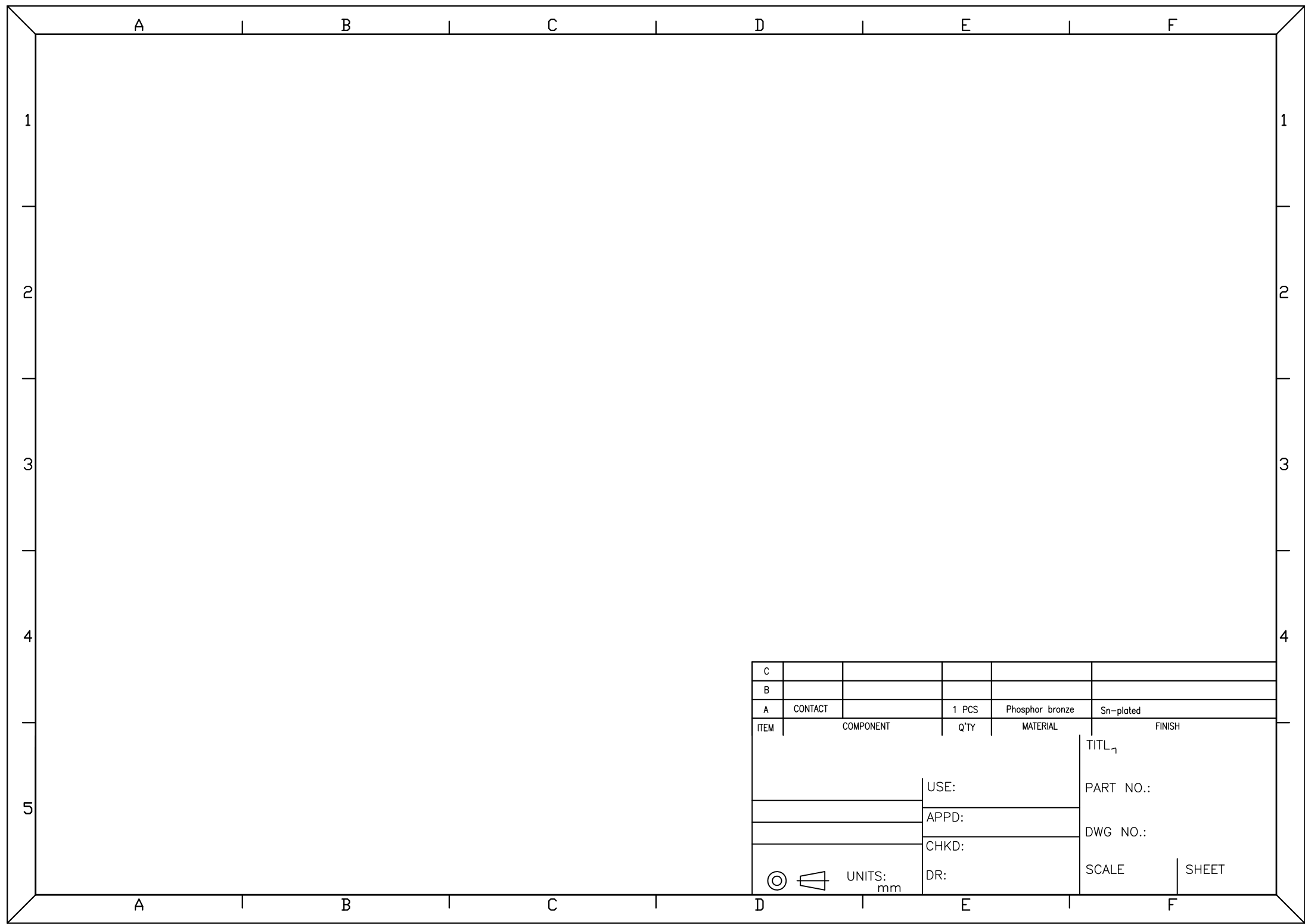

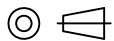
C					
B					
A	CONTACT		1 PCS	Phosphor bronze	Sn-plated
ITEM	COMPONENT	Q'TY	MATERIAL	FINISH	
				TITL ₁	
				PART NO.:	
				DWG NO.:	
				SCALE	SHEET
 UNITS: mm		USE:			
		APPD:			
		CHKD:			
		DR:			

A

B

C

D

E

F

REV	ECN No.	DESCRIPTION	DESIGN	DATE

1

1

2

2

3

3

4

4

5

WENZHOU JKUN CONNECT			TITLE:	
		USE:	PART NO.:	
		APPD:	DWG NO.:	
		CHKD:	SCALE	SHEET
		DR:		

RoHS



UNITS: mm

B

C

D

E

F

包装说明:

1. 把成品包入卷盘中, 每盘装1000PCS,

卷



